

HMHIL- 10(T01LOU)

Type: O-ring Mechanical Seal
 Replacement: AES T02LOU
 Temperature: -20 to +140°C
 Pressure: $\leq 1\text{Mpa}$
 Speed: $\leq 15\text{m/s}$
 Material: B,Q2,U2,P,E,N,V,F,G,Alfa

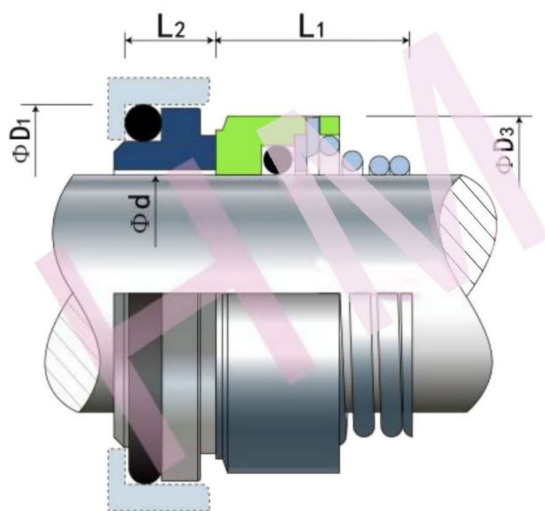

d (mm)	D1	D3	L1	L2
19	35	31	22.0	7.5
28	42	42	26.5	9.0
30	45	44	25.0	10.5
38	55	54	32.2	10.3
40	58	56	34.7	10.8
50	70	66	45.9	11.6
d (mm)	D1	D3	L1	L2
0.748	1.378	1.26	0.866	0.295
1.102	1.654	1.653	1.043	0.354
1.181	1.772	1.732	0.984	0.413
1.496	2.165	2.126	1.268	0.406
1.575	2.283	2.205	1.366	0.425
1.969	2.756	2.598	1.799	0.457